



Product Information

SP2-LUTE

CompactPCI® Serial • PCI Express® Mini Card Carrier

Document No. 6478 • 18 February 2014

General

The SP2-LUTE is a peripheral board for CompactPCI® Serial systems. The board is suitable as a carrier for two PCI Express® Mini Cards, either full- or half-size style, and supports both, USB2.0 based and PCIe based Mini Cards. Up to six SMA antenna connectors are available via the front panel, for MIMO operation of wireless Mini Cards, such as WiFi (WLAN) or WiMax. Two SIM card holders are provided on the SP2-LUTE, e.g. for usage together with GPRS or LTE modem Mini Cards.

The SP2-LUTE is equipped with an on-board PCI Express® packet switch and quad PCIe to USB 2.0 bridge, and can be installed into any peripheral slot of a CompactPCI® Serial backplane.

In addition, the SP2-LUTE is provided with an expansion connector, for optional attachment of an on-board low profile mezzanine storage module (EKF C4*- Series), either SATA or USB based.



SP2-LUTE

System Integration Options

The SP2-LUTE is a CompactPCI® Serial peripheral card. CompactPCI® Serial (CPCI-S.0) is a new PICMG® standard for modular industrial computers, which provides high speed serial I/O (PCI Express®, SATA, USB, Gigabit Ethernet) over the backplane. The CPCI-S mechanical design is fully backward compatible to CompactPCI® Classic and will interoperate with existing systems, by means of a hybrid backplane.

Hybrid systems (providing card slots for both CPCI Classic & CPCI Serial) can be configured by means of a CompactPCI® PlusIO CPU card such as the PC1-GROOVE or PC2-LIMBO in combination with a suitable hybrid backplane.

Native CompactPCI® Serial systems (up to 8 CPCI Serial peripheral card slots) can be built around a suitable system slot CPU board such as the SC1-ALLEGRO.

Major Benefits

- ▶ PICMG® CompactPCI® Serial Standard (CPCI-S.0) Peripheral Slot Card
- ▶ Single Size Eurocard 3U 4HP 100x160mm²
- ▶ Backplane Connector P1
- ▶ 2 x PCI Express® Mini Card Sockets, Full-Size or Half-Size Cards
- ▶ PCI Express® Mini Cards Both Types USB Based and PCIe Based Supported
- ▶ Six F/P Antenna Connectors SMA R/P for MIMO Wireless Applications
- ▶ 2 x SIM Card Holder
- ▶ J-HSE Expansion Connector Suitable for Optional C4* Low Profile Mezzanine Module
- ▶ Long Term Availability
- ▶ Rugged Solution (Coating/Sealing Available on Request)
- ▶ RoHS compliant

Theory of Operation

The SP2-LUTE requires a single PCI Express® lane from the backplane, passed over across the connector P1 to a PCIe packet switch (upstream port). The PCIe downstream ports from the switch are used to supply each Mini Card socket with a PCI Express® lane. In addition, the PCIe switch incorporates a quad port USB controller. Two of the USB channels are dedicated to the Mini Card sockets. Another two USB ports are wired to the mezzanine expansion connector J-HSE for optional usage.

By specification, any CompactPCI® Serial peripheral slot may convey a single SATA and a single USB channel, available from the backplane via P1. These ports are both routed to the mezzanine expansion connector J-HSE, in addition to the USB lines from the on-board USB controller. The SATA Rx/Tx signals are reconditioned by a 6Gbps SATA redriver, for optimum performance. A variety of J-HSE compliant C4*-Series low profile mezzanine modules is available as an option.



SP2-LUTE

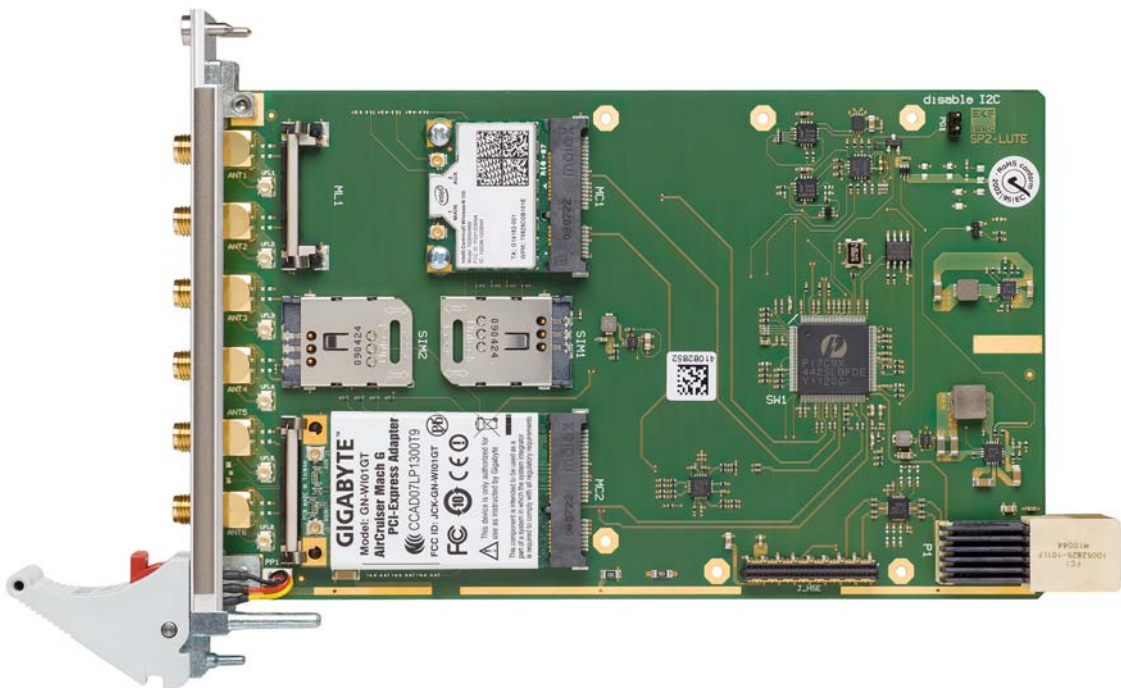

Block Diagram

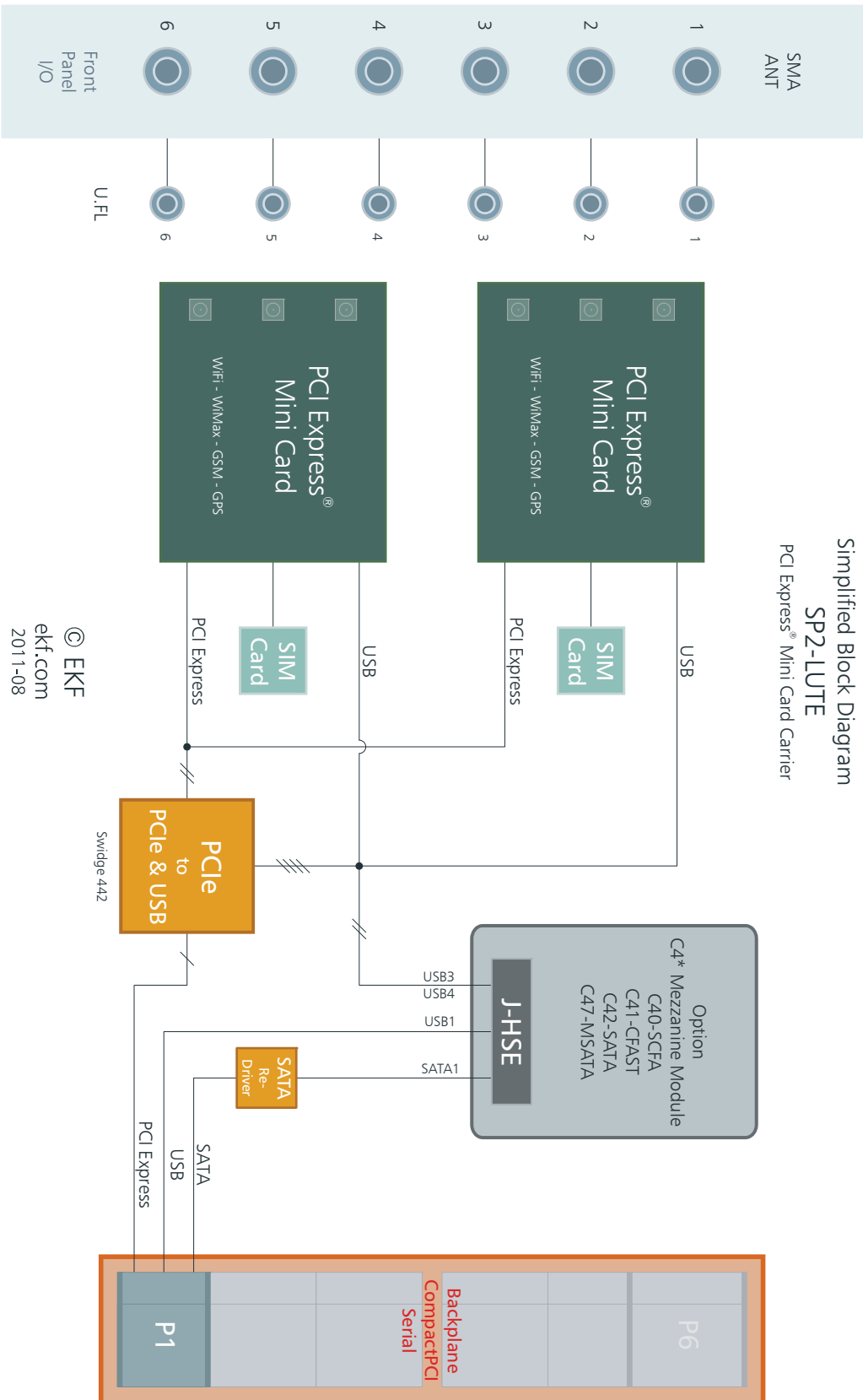

Simplified Block Diagram
SP2-LUTE
 PCI Express® Mini Card Carrier

© EKF
 ekf.com
 2011-08

Component Assembly Options

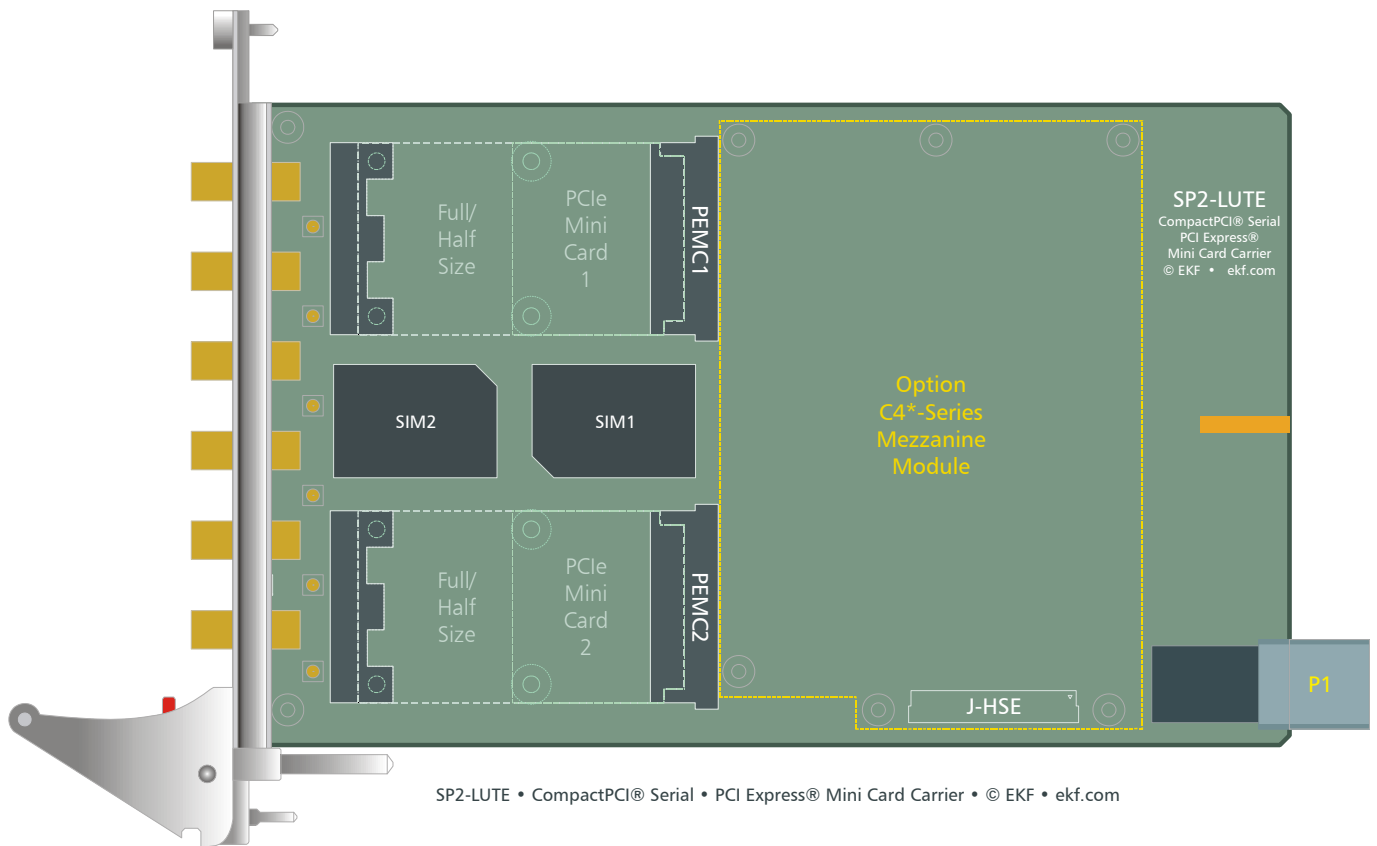

Low Profile CPU Card Mezzanine Storage Modules		
C40-SCFA	CompactFlash®	www.ekf.com/c/ccpu/c40/c40_tie.pdf
C41-CFAST	CFast™	www.ekf.com/c/ccpu/c41/c41_tie.pdf
C42-SATA	Micro SATA	www.ekf.com/c/ccpu/c42/c42_tie.pdf
C47-MSATA	Dual mSATA	www.ekf.com/c/ccpu/c47/c47.html
Overview	J-HSE/P-MEZ Based Modules	www.ekf.com/c/ccpu/c4x_mezz_oww.pdf

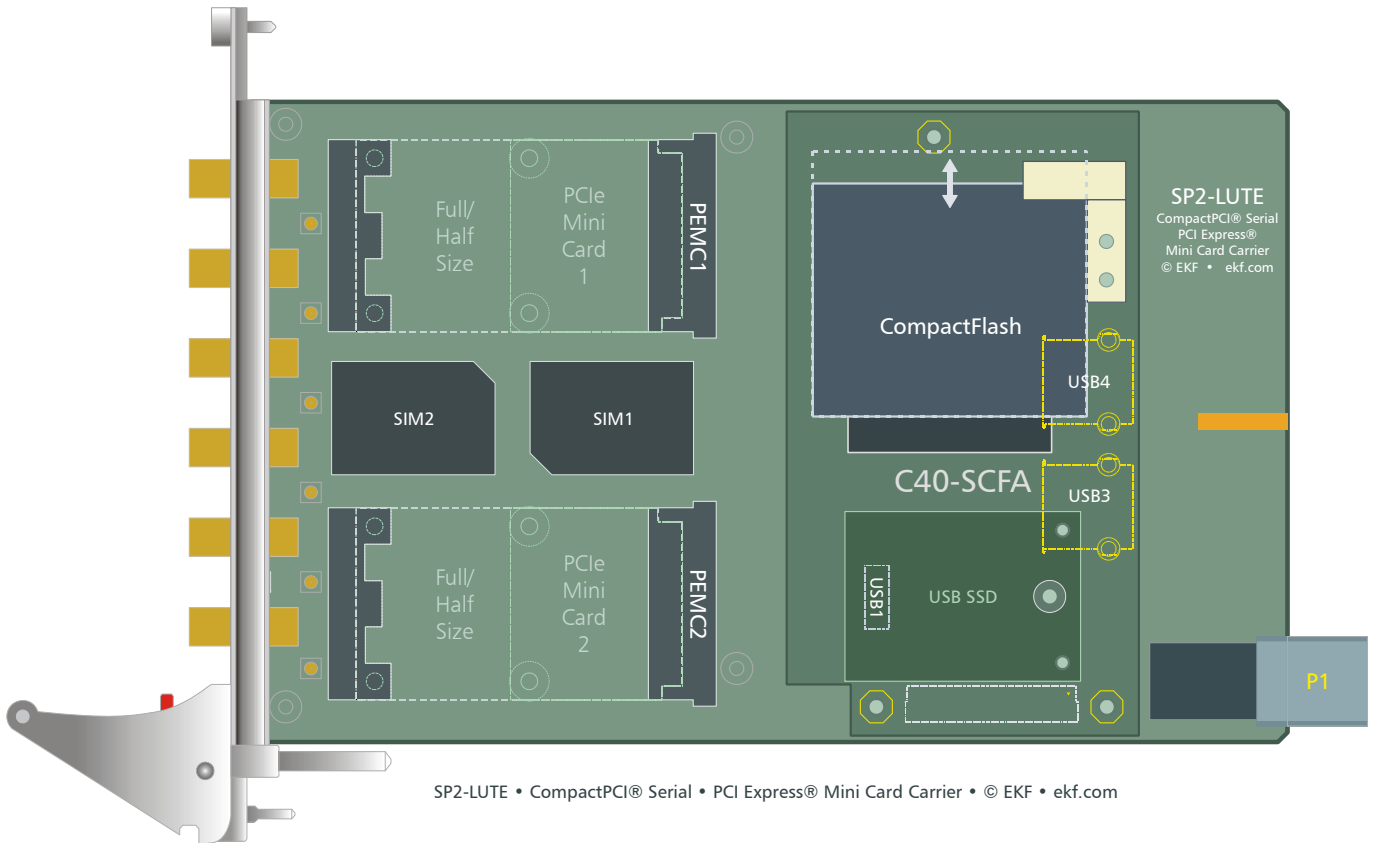

SP2-LUTE • CompactPCI® Serial • PCI Express® Mini Card Carrier • © EKF • ekf.com

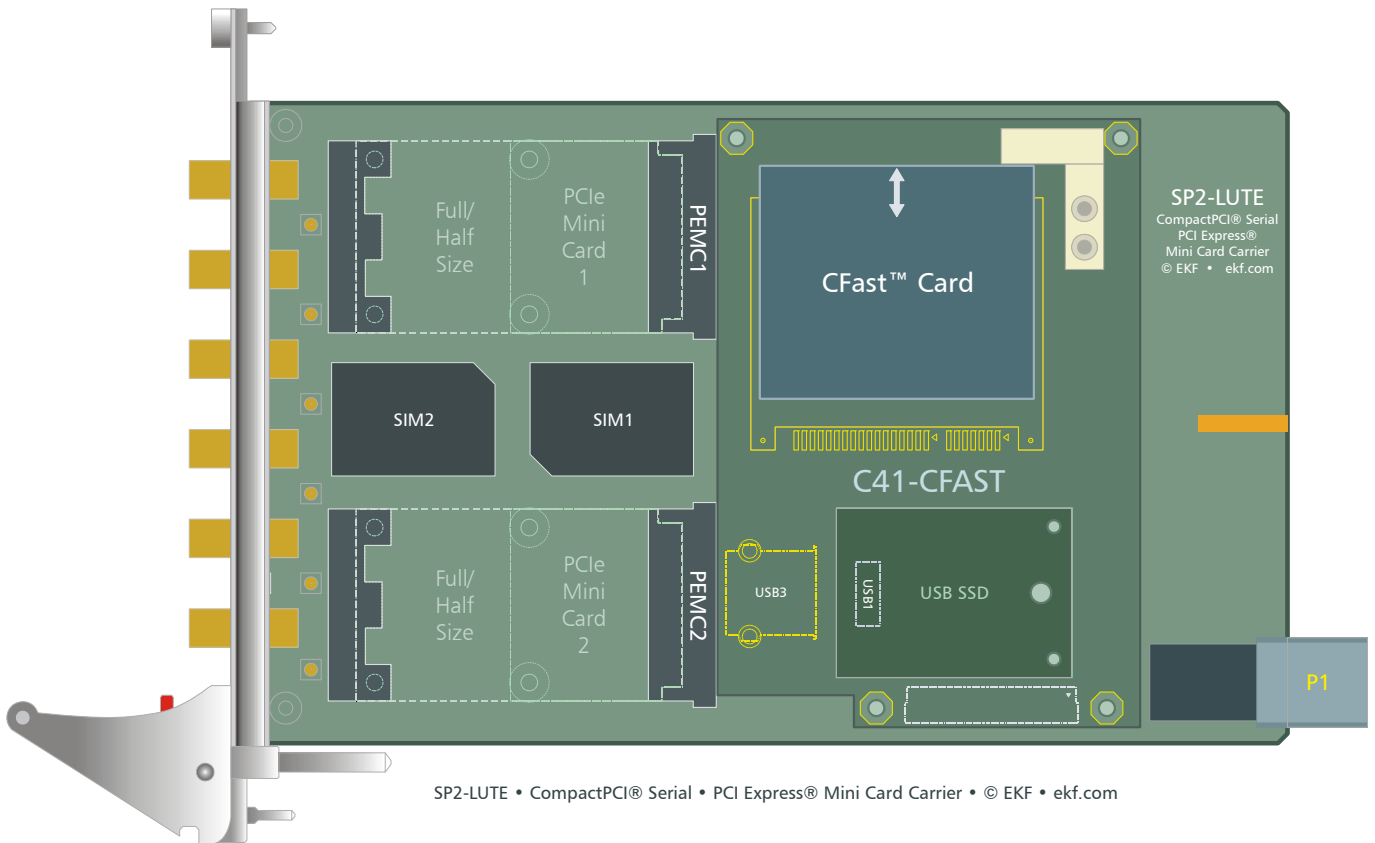

SP2-LUTE • CompactPCI® Serial • PCI Express® Mini Card Carrier • © EKF • ekf.com

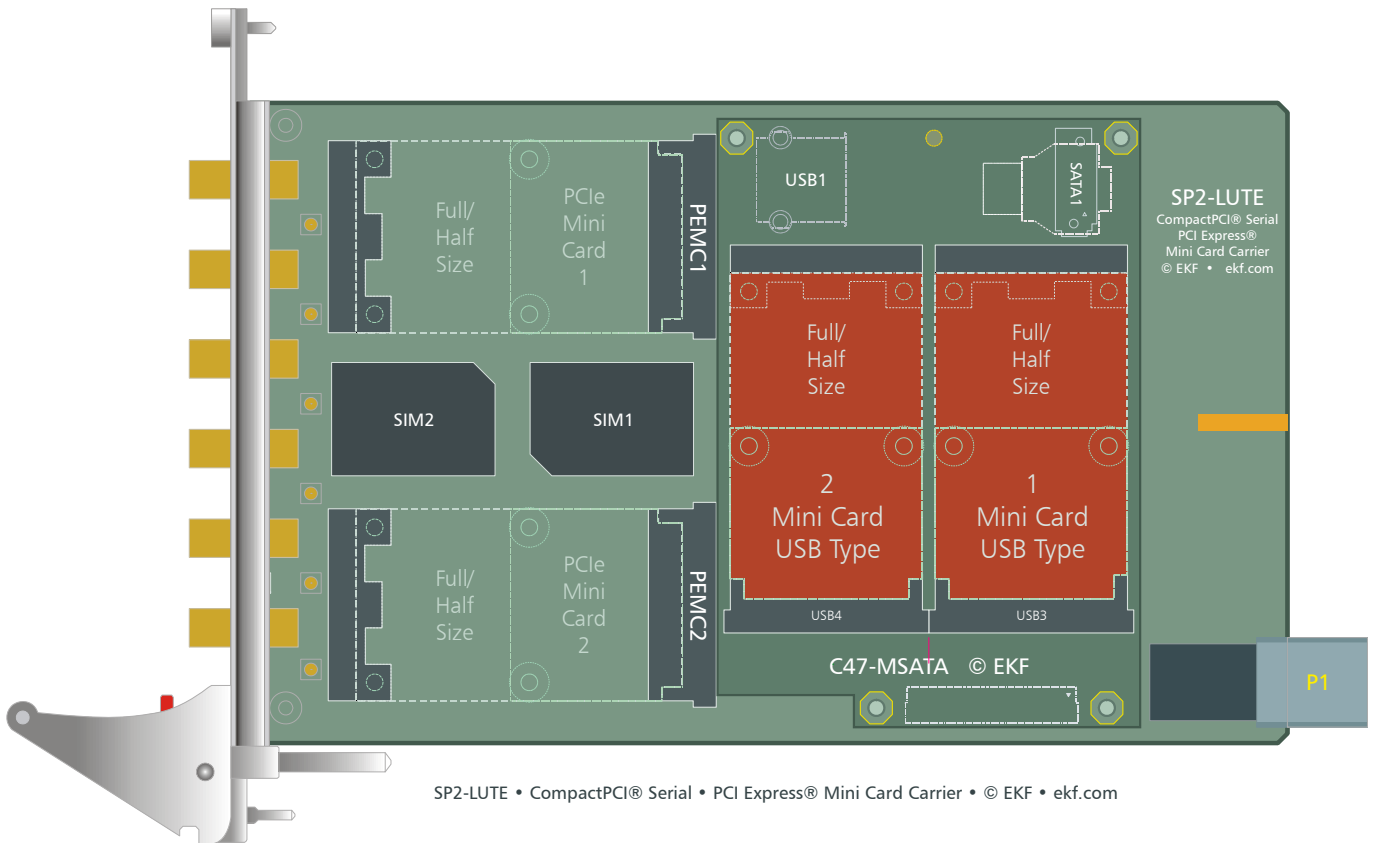
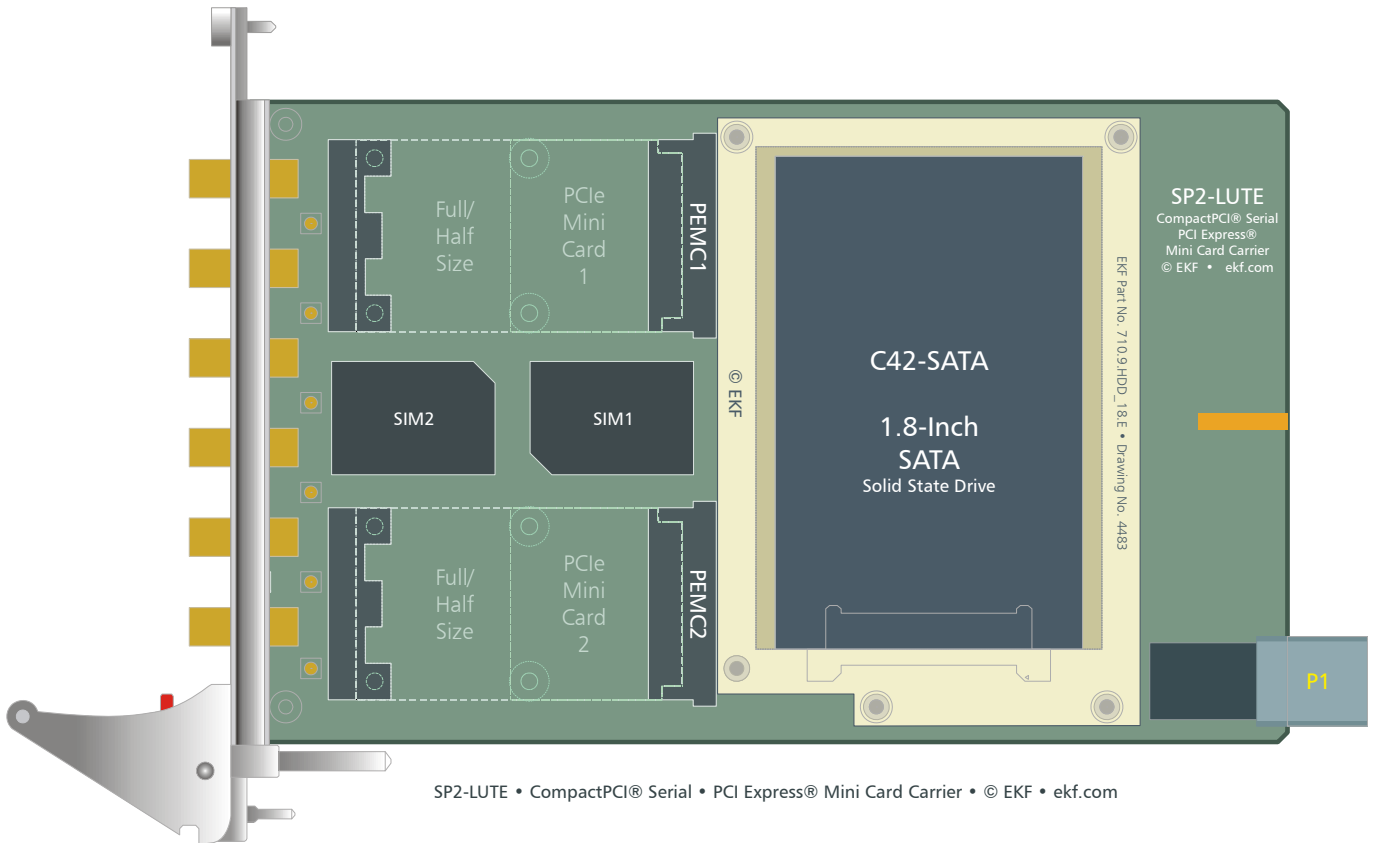



C40-SCFA • CompactFlash® Card Holder

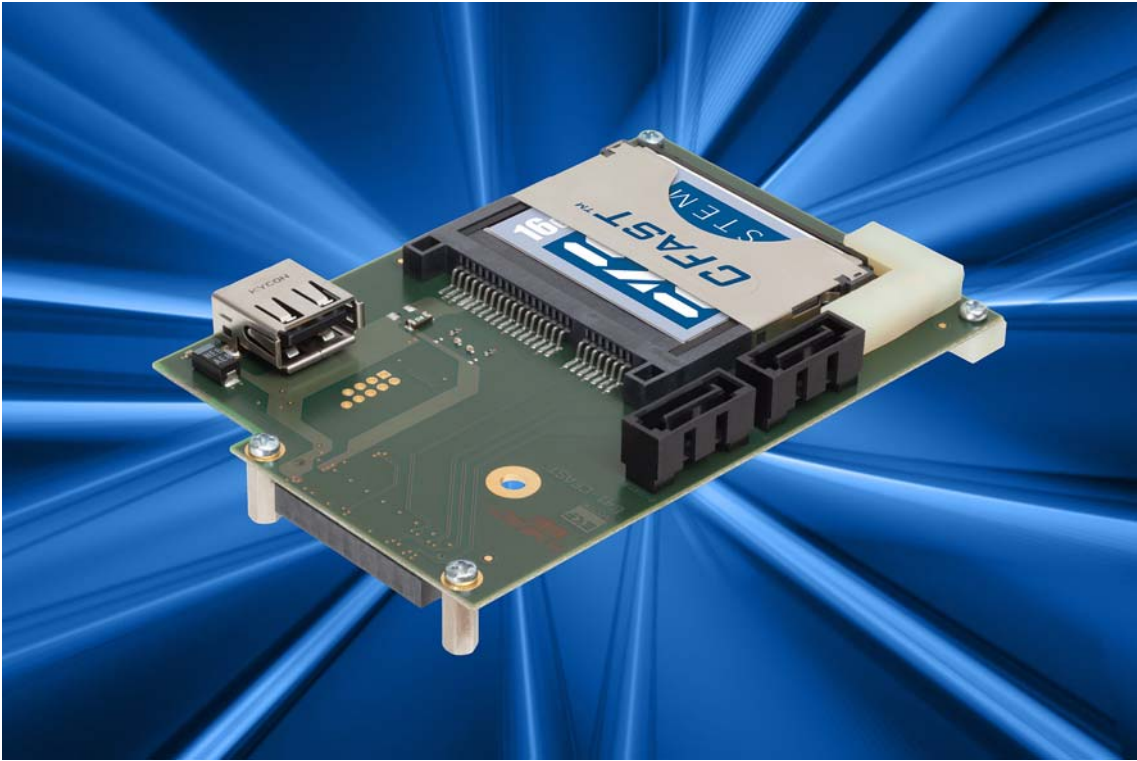

C41-CFAST • CFAST™ Card Holder



C42-SATA • Solid State Drive Mezzanine Module



SP2-LUTE with C42-SATA



C47-MSATA • Mini Card Sockets (USB Type)



Mezzanine Module Area

Front Panel



© EKF • draft - do not scale • ekf.com

SP2-LUTE

Mini Card Host Connectors

The SP2-LUTE is provided with two PCI Express® Mini Card Host Connectors. These are suitable for PCIe based modules, and also USB 2.0 driven Mini Card modules. After inserted, the Mini Card has to be fixed by a snap-in latch (full-size modules 50.80mm length), or will have to be secured manually by screws (mini size modules 26.80mm length), in order to withstand shock and vibration.

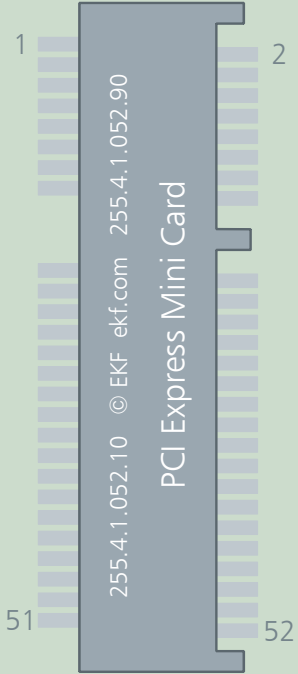
PEMC1 & PEMC2				
PCI Express® Mini Card Socket (255.4.1.052.10) & Latch (255.4.1.052.90)				
	PCIE_WAKE#	1	2	+3.3V
	NC	3	4	GND
	NC	5	6	+1.5V
	NC CLKREQ#	7	8	UIM_C1
	GND	9	10	UIM_C7
	PCIE_CLK-	11	12	UIM_C3
	PCIE_CLK+	13	14	UIM_C2
	GND	15	16	UIM_C6
	NC	17	18	GND
	NC	19	20	NC WDIS#
	GND	21	22	RST#
	PCIE_RN	23	24	+3.3V
	PCIE_RP	25	26	GND
	GND	27	28	+1.5V
	GND	29	30	SMB_CLK
	PCIE_TN	31	32	SMB_DAT
	PCIE_TP	33	34	GND
	GND	35	36	USB1(2)_D-
	NC	37	38	USB1(2)_D+
	NC	39	40	GND
	NC	41	42	LED_WWAN#
	NC	43	44	LED_WLAN#
	NC	45	46	LED_WPAN#
	NC	47	48	+1.5V
NC	49	50	GND	
NC	51	52	+3.3V	

+1.5V is generated from an on-board DC/DC converter, with a maximum regulator output current of 2A in total for both host Mini Card connectors. Since typical PCI Express® Mini Card modules have no need for this secondary supply voltage, the DC/DC converter may be left unpopulated for cost sensitive applications.

The Mini Card sockets are not suitable for some proprietary modules, which may provide special services, e.g. voice I/O, resulting in conflicts with the host connector pin assignment. Be sure that your Mini Card complies with the PCI Express® Mini Card Specification (PCI-SIG). Furthermore, mSATA modules are not supported.

Full size Mini Cards are fixed by a latching (snap-in) element at the module end. A half size Mini Card must be fastened manually by screws M2.5x6mm through corresponding M2.5 soldered nuts provided on the SP2-LUTE PCB. 1.5mm height nylon washers are required in addition as spacing elements between the PCB nuts and the half size Mini Card.

Part Numbers for Fixing a Half Size Mini Card		
2	440.42.025.015	M2.5 PCB nut, bottom mount (populated on-board by default)
2	440.26.025.015	Self retaining nylon washer 1.5mm height (spacer)
2	440.28.025.000	Locking washer
2	440.08.025.006	Screw M2.5 x 6mm

Another approach would be to use a mechanical extender on half size Mini Cards, as shown below:

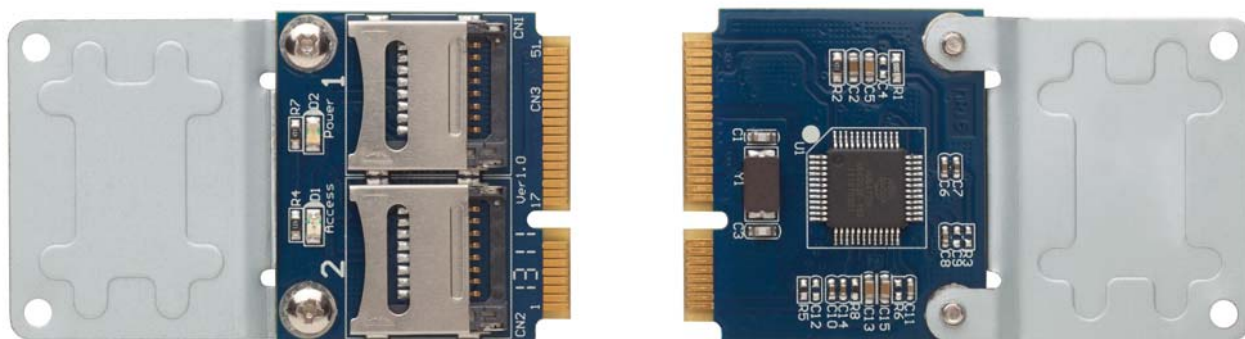



Coax Connector Removing Tool



SP2-LUTE in a BLUBOXX Small Computer System

J-HSE Mezzanine Connector

J-HSE is a high speed mezzanine connector, which conveys (with respect to the SP2-LUTE) 1 x SATA and 3 x USB ports. The SATA channel has been derived from the backplane connector P1, and also USB1. USB3 and USB4 are generated by the on-board PCIe to USB bridge.

High Speed Expansion J-HSE				
	GND	a1	b1	GND
	SATA1_TXP	a2	b2	<i>SATA3_TXP</i>
	SATA1_TXN	a3	b3	<i>SATA3_TXN</i>
	GND	a4	b4	GND
	SATA1_RXN	a5	b5	<i>SATA3_RXN</i>
	SATA1_RXP	a6	b6	<i>SATA3_RXP</i>
	GND	a7	b7	GND
	<i>SATA2_TXP</i>	a8	b8	<i>SATA4_TXP</i>
	<i>SATA2_TXN</i>	a9	b9	<i>SATA4_TXN</i>
	GND	a10	b10	GND
	<i>SATA2_RXN</i>	a11	b11	<i>SATA4_RXN</i>
	<i>SATA2_RXP</i>	a12	b12	<i>SATA4_RXP</i>
	GND	a13	b13	GND
	USB1_P	a14	b14	USB3_P
	USB1_N	a15	b15	USB3_N
	GND	a16	b16	GND
	<i>USB2_P</i>	a17	b17	USB4_P
	<i>USB2_N</i>	a18	b18	USB4_N
	GND	a19	b19	GND
	<i>USB1_OC#</i>	a20	b20	<i>USB3_OC#</i>
	<i>USB2_OC#</i>	a21	b21	<i>USB4_OC#</i>
	+3.3V	a22	b22	+5V
	+3.3V	a23	b23	+5V
	+3.3V	a24	b24	+5V
	<i>RSVD</i>	a25	b25	<i>RSVD</i>

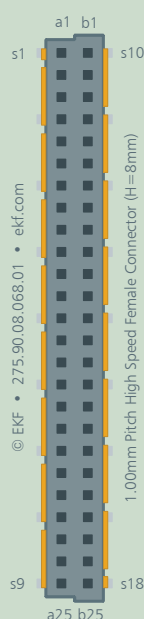

Italic/Grey: Signals not supported (NC)

WARNING: The +3.3V/+5V power pins are not protected against a short circuit event. The connector J-HSE therefore should be used only for attachment of an approved expansion side card. The maximum current flow through these power pins should be limited to <0.5A per pin.

Related Documents

Suitable CPU Cards	
PC1-GROOVE	CompactPCI® PlusIO CPU Card, for Hybrid Backplanes www.ekf.com/p/pc1/pc1.html
PC2-LIMBO	CompactPCI® PlusIO CPU Card, for Hybrid Backplanes www.ekf.com/p/pc2/pc2.html
SC1-ALLEGRO	CompactPCI® Serial CPU Card, for Native CompactPCI® Serial Backplanes www.ekf.com/s/sc1/sc1.html

Reference Documents		
Term	Document	Origin
PCI Express® Mini Card	PCI Express® Mini Card Electromechanical Specification	www.pcisig.com
SATA	Serial ATA Specification	www.sata-io.org
USB	Universal Serial Bus Specification	www.usb.org

Ordering Information

Ordering Information

For popular SP2-LUTE SKUs please refer to www.ekf.com/liste/liste_21.html#SP2

For popular Mezzanine Side Cards please refer to www.ekf.com/liste/liste_20.html#C40



Industrial Computers Made in Germany
boards. systems. solutions.

EKF Elektronik GmbH
Philipp-Reis-Str. 4 (Haus 1)
Lilienthalstr. 2 (Haus 2)
59065 HAMM
Germany



Phone +49 (0)2381/6890-0
Fax +49 (0)2381/6890-90
Internet www.ekf.com
E-Mail sales@ekf.com