



Product Information

DC2-STAG • XMC Module

PCI Express® External Cabling • Host Side Adapter • PCIe x4 Cable Connectors

Document No. 7601 • 29 September 2016



DC2-STAG

Most computer systems are based on the PCI Express® standard as a high speed backbone for interconnection of peripheral components with a host CPU. Typically all PCI Express® based devices are located closely in a common enclosure.

The PCI-SIG PCI Express® External Cabling Specification addresses extended applications, such as split-systems or I/O expansion by means of a suitable copper cable, available e.g. for a x 4 PCI Express® link, up to 7m length. When used with an AOC (Active Optical Cable), distances of up to 300m can be bridged between host and target systems.

Coupling systems by PCI Express® is a solution which allows significantly more throughput and lower latency compared e.g. to 1 or 10 Gigabit Ethernet. Thus, remote target systems become a genuine part of the host.

The DC2-STAG is a XMC style mezzanine card, designed for dual PCIe x 4 external cabling (host system adapter). The board is provided with two PCIe x 4 front panel connectors, for attachment of one or two remote target systems via PCI Express®.

For optimum performance, the DC2-STAG requires a PCIe x 8 Gen2 capable XMC carrier board. This would allow both cabling connectors to be operated simultaneously with PCIe Gen2 speed, at full throughput. For typical applications, a PCIe x 4 based XMC carrier may be also adequate.

The on-board PCIe Gen2 packet switch splits the upstream link (x 8 or x 4 from XMC connector P15) into two equal downstream links (x 4), each delivering up to 20GT/s to an associated target system. Dual clocking is provided on the DC2-STAG, which allows usage of CFC restricted cables (such as AOC) in a SSC host system.

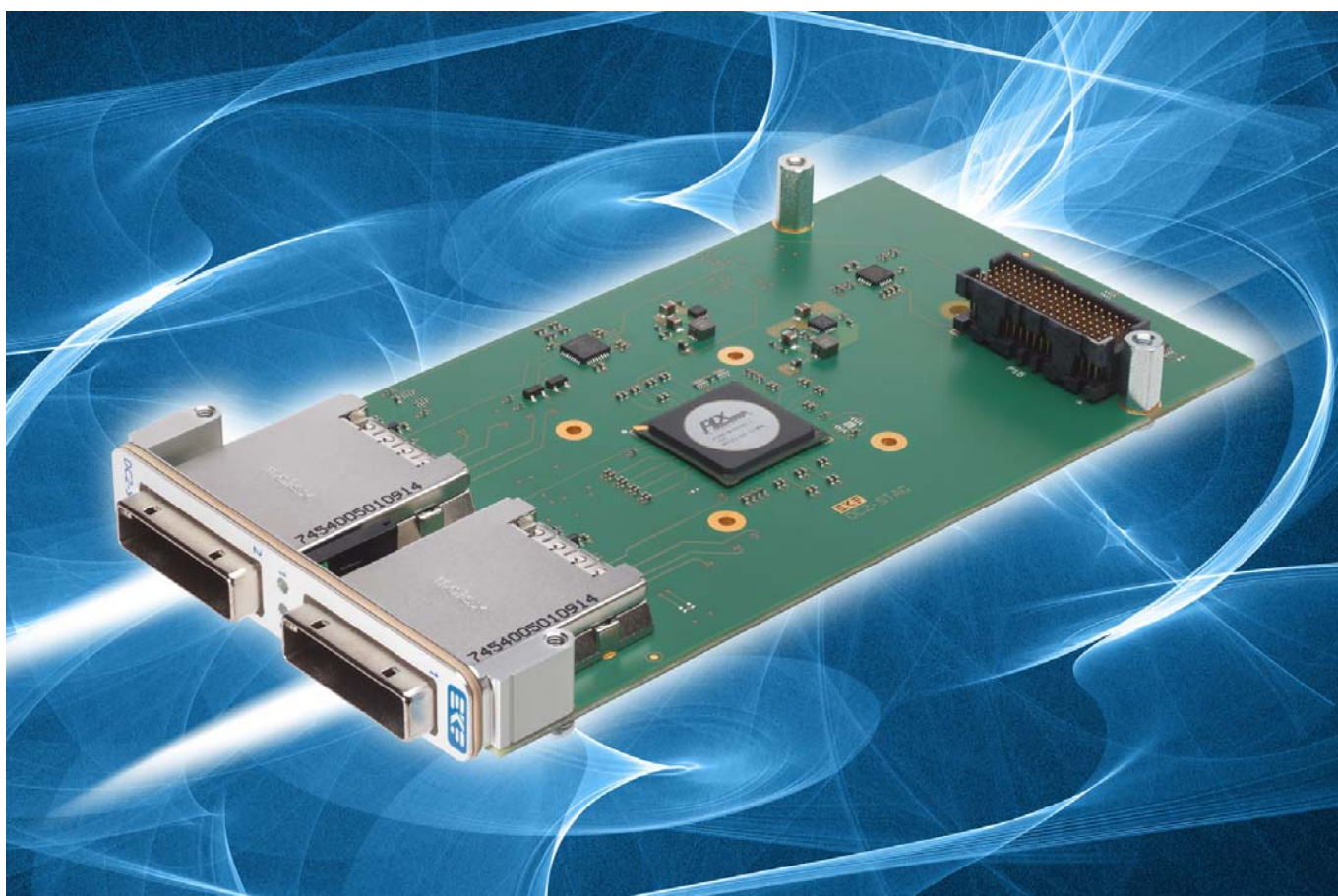

DC2-STAG

Feature Summary

General

- ▶ Form factor XMC single-width mezzanine card 139mm x 74mm
- ▶ Stack height 10mm XMC to host
- ▶ Host I/F connector P15 XMC (option XMC 2.0)
- ▶ x 8 or x 4 PCI Express® 2.0 (5.0 Gbps)
- ▶ +3.3V only operated (VPWR not in use)

I/O Connectivity

- ▶ PCI Express® External Cabling Specification
- ▶ Two connectors PCIe x 4 38-pos. (front bezel), two target systems can be attached simultaneously
- ▶ Suitable for remote target systems to be controlled by any XMC enabled host system
- ▶ Split-systems, hybrid systems, or system expansion applications
- ▶ Connects to any PCIe based target system with PCI Express® x 4 external cabling adapter
- ▶ Copper cable assemblies 0.5m to 7m length available
- ▶ Active optical cable assemblies (AOC) up to 300m length available
- ▶ PCIe Gen2 x 4 allows for up to 20GT/s bandwidth

On-Board Components

- ▶ Gen2 PCI Express® 16-lanes packet switch on-board
- ▶ Dual clocking option for separation from host system spread spectrum clock (SSC) domain, cable ports can be setup to constant frequency clock (CFC), as required for active optical cables (AOC)
- ▶ Selectable protocol for cable ports PCIe Gen1 or Gen2

Applications

- ▶ For lowest latency at fastest speed connected systems
- ▶ Distributed computing - host to target system hierarchy
- ▶ Peer to peer computing - special TCP/IP stack (Dolphin) available
- ▶ Split-systems, hybrid systems, or system expansion applications
- ▶ Direct host to target device connection (e.g. PCIe based remote NVMe mass storage)
- ▶ Vision systems with high resolution cameras directly attached

Environmental, Regulatory

- ▶ Designed & manufactured in Germany - ISO 9000 quality management certified
- ▶ Long term availability
- ▶ Rugged solution
- ▶ Coating, sealing, underfilling on request
- ▶ RoHS compliant 2002/95/EC
- ▶ Operating temperature: 0°C to +70°C
- ▶ Industrial temperature range -40°C to +85°C on request
- ▶ Storage temperature: -40°C to +85°C, max. gradient 5°C/min
- ▶ Humidity 5% ... 95% RH non condensing
- ▶ Altitude -300m ... +3000m
- ▶ Shock 15g 0.33ms, 6g 6ms
- ▶ Vibration 1g 5-2000Hz
- ▶ MTBF 65.7years
- ▶ EC Regulatory EN55022, EN55024, EN60950-1 (UL60950-1/IEC60950-1)

items are subject to changes

Related Information	
Ordering Information	www.ekf.com/liste/liste_22.html#DC2
DC2-STAG Home	www.ekf.com/d/dpxc/dc2/dc2.html

Block Diagram

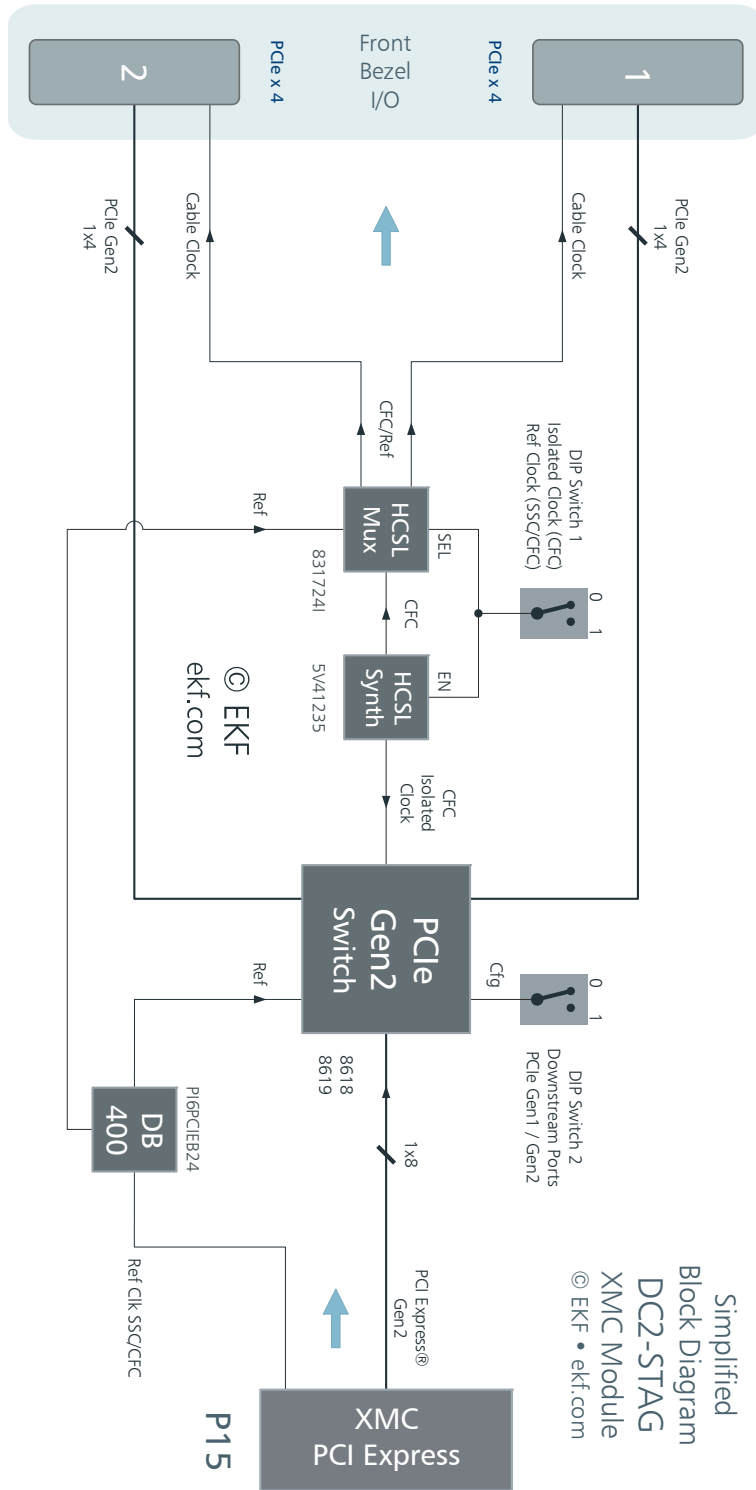

Front Bezel Options



© EKF • draft - do not scale • ekf.com

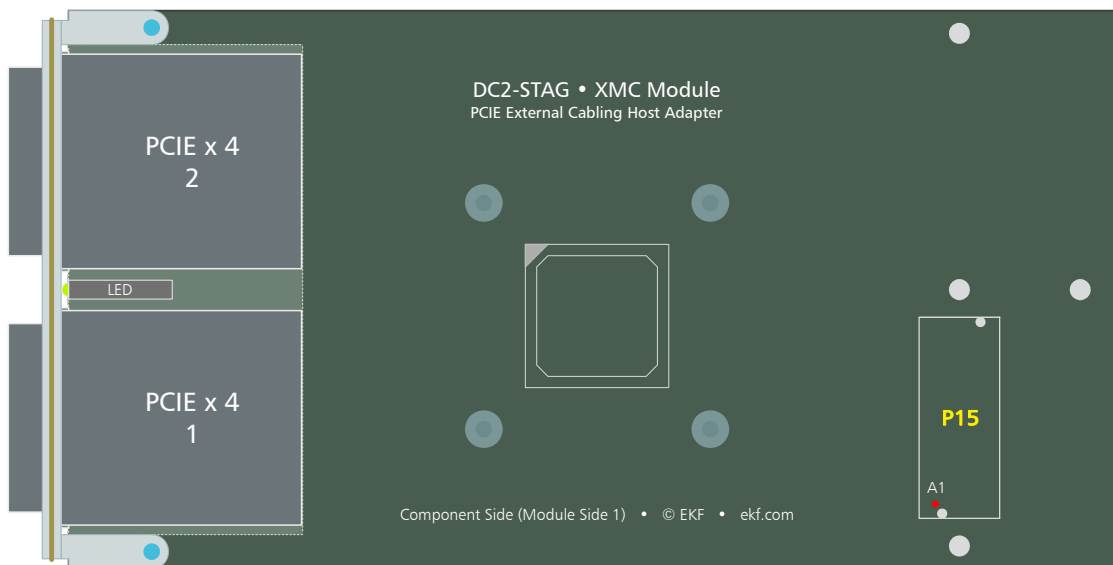

PCIe x 4 Cable Connectors

Front Bezel Connectors PCIe x 4				
EKF Parts #255.3.4.038.00 (Receptacle) & 255.3.4.138.00 (Guide Frame)				
<p>Part #255.3.4.038.00 & 255.3.4.138.00 draft - do not scale • © EKF • ekf.com</p>	GND	A1	B1	GND
	PETp0	A2	B2	PERp0
	PETn0	A3	B3	PERn0
	GND	A4	B4	GND
	PETp1	A5	B5	PERp1
	PETn1	A6	B6	PERn1
	GND	A7	B7	GND
	PETp2	A8	B8	PERp2
	PETn2	A9	B9	PERn2
	GND	A10	B10	GND
	PETp3	A11	B11	PERp3
	PETn3	A12	B12	PERn3
	GND	A13	B13	GND
	CREFLKp	A14	B14	PWR +3.3V
	CREFLKn	A15	B15	PWR +3.3V
	GND	A16	B16	PWR_RTN 1)
	SB_RTN 2)	A17	B17	PWR_RTN 1)
	CPRSNT# 3)	A18	B18	CWAKE# 3)
	CPWRON 4)	A19	B19	CPEST# 4)

PWR +3.3V - protected by on-board PolyFuse 1.5A

For signal descriptions please refer to PCI Express External Cabling Specification Rev. 2.0

- 1) connected to GND
- 2) Sideband reference GND
- 3) Input from Downstream System (Target) to Upstream System (Host)
- 4) Output from Upstream System (Host) to Downstream System (Target)

PCIe x 4 Cable Assemblies	
255.3.4.938.0.020	PCIe x 4 external cable assembly, 38-circuit, 2m
255.3.4.938.0.040	PCIe x 4 external cable assembly, 38-circuit, 4m
255.3.4.938.0.050	PCIe x 4 external cable assembly, 38-circuit, 5m
255.3.4.938.0.070	PCIe x 4 external cable assembly, 38-circuit, 7m
255.3.4.938.8.0100	PCIe x 4 external active optical cable assembly, 10m
other configurations on request	

For distances up to 300m between host system and target system active optical cables (AOC) are recommended. Below 7m (e.g. when connecting racks in a common enclosure) a low cost copper cable is sufficient. Please note, that an AOC employs a host side connector and a target side connector, which must not be interchanged. A PCI Express® copper cable however is configured identical at both endings. While a copper cable is spread spectrum clock (SSC) compatible, the AOC requires a constant frequency clock (CFC). For proper operation over AOC, setup the host interface (DC2-STAG) for CFC.



Active Optical Cable Connector



Copper Cable Connector

Cable Port Setup

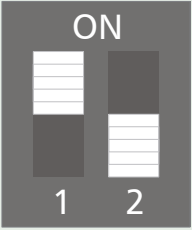
On-Board DIP Switch			
		1 - Cable Clock	2 - Cable Speed
 <p>160.15.02.0 © EKF • ekf.com</p>	Dual (Split) Clock Discrete CFC assigned to cable ports 3) (Default)	ON PCIe Gen 1 1)	
	Reference Clock System clock SSC/CFC passed through to cable ports 4)	OFF PCIe Gen 2 2) (Default)	

Settings are common to both cable ports

- 1) Forces PCIe switch to fall back to Gen1 (downstream cable ports only)
- 2) Cable ports self-adjusting for PCIe Gen1 / Gen2 speed according to target side capability
- 3) Optical cables require CFC (constant frequency clock)
- 4) Copper cables up to 7m length are compliant with both SSC & CFC

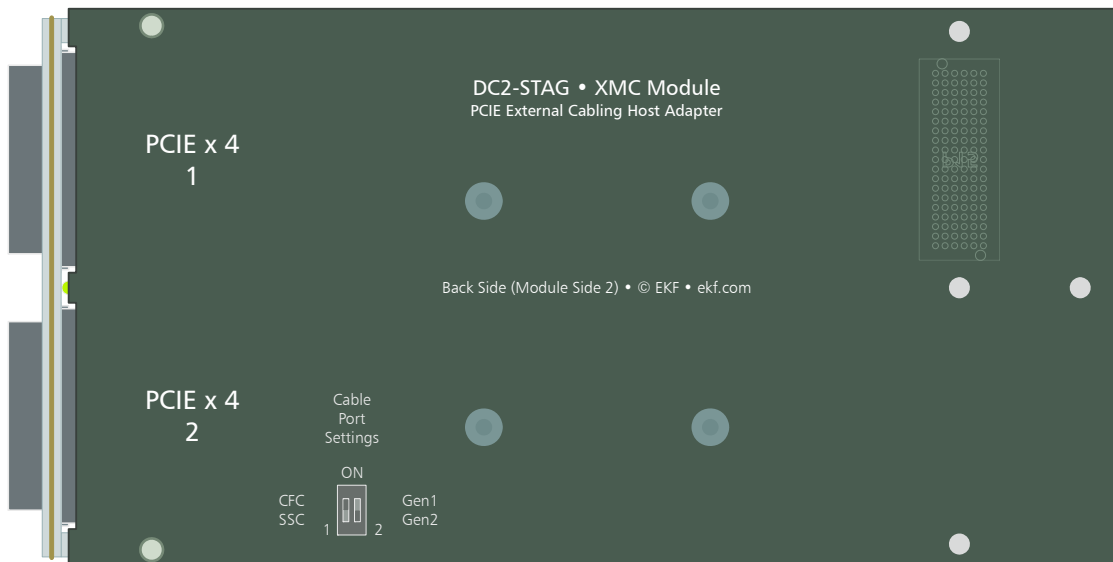

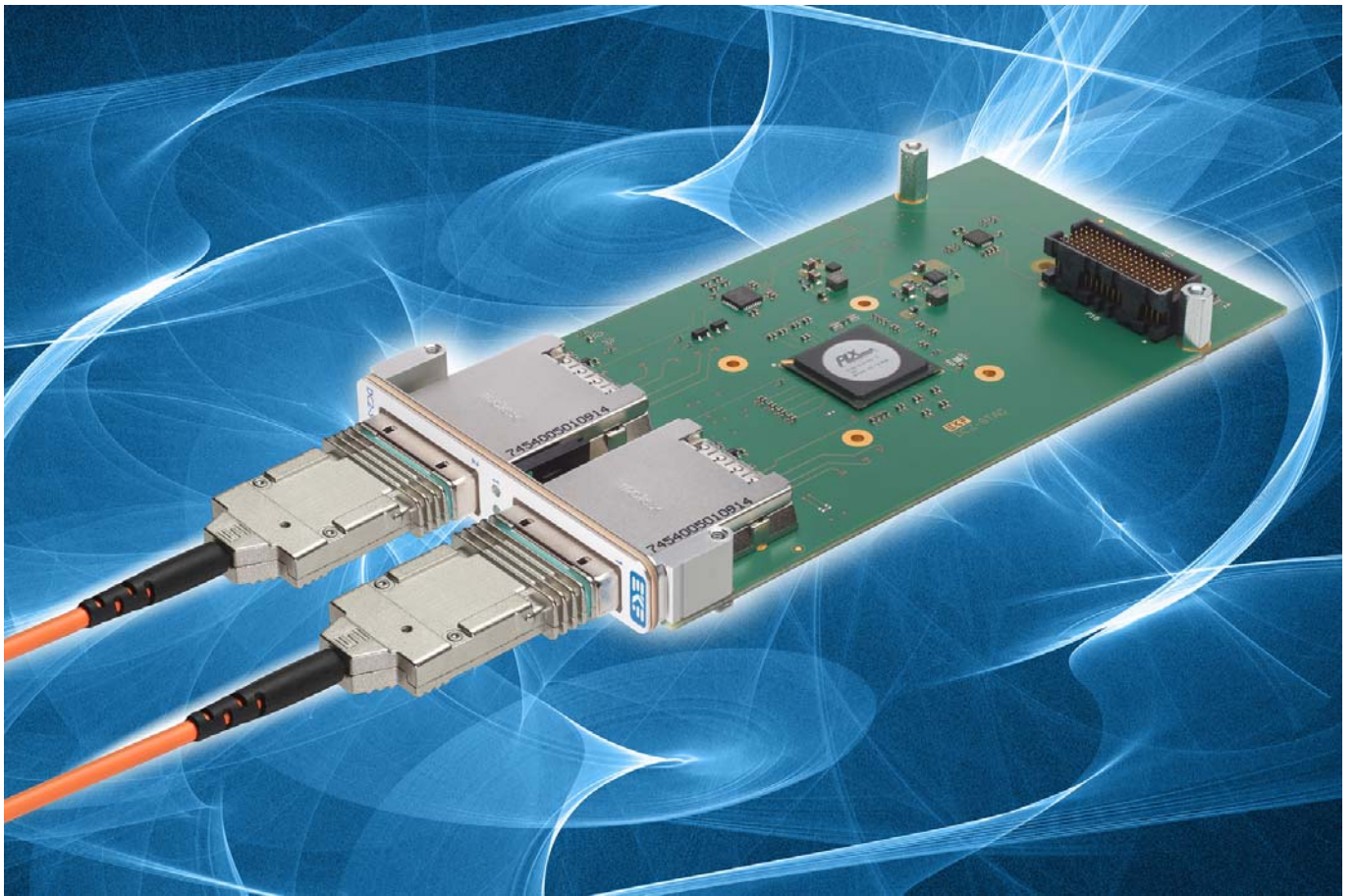

DC2-STAG w. Active Optical Cable

Typical Application

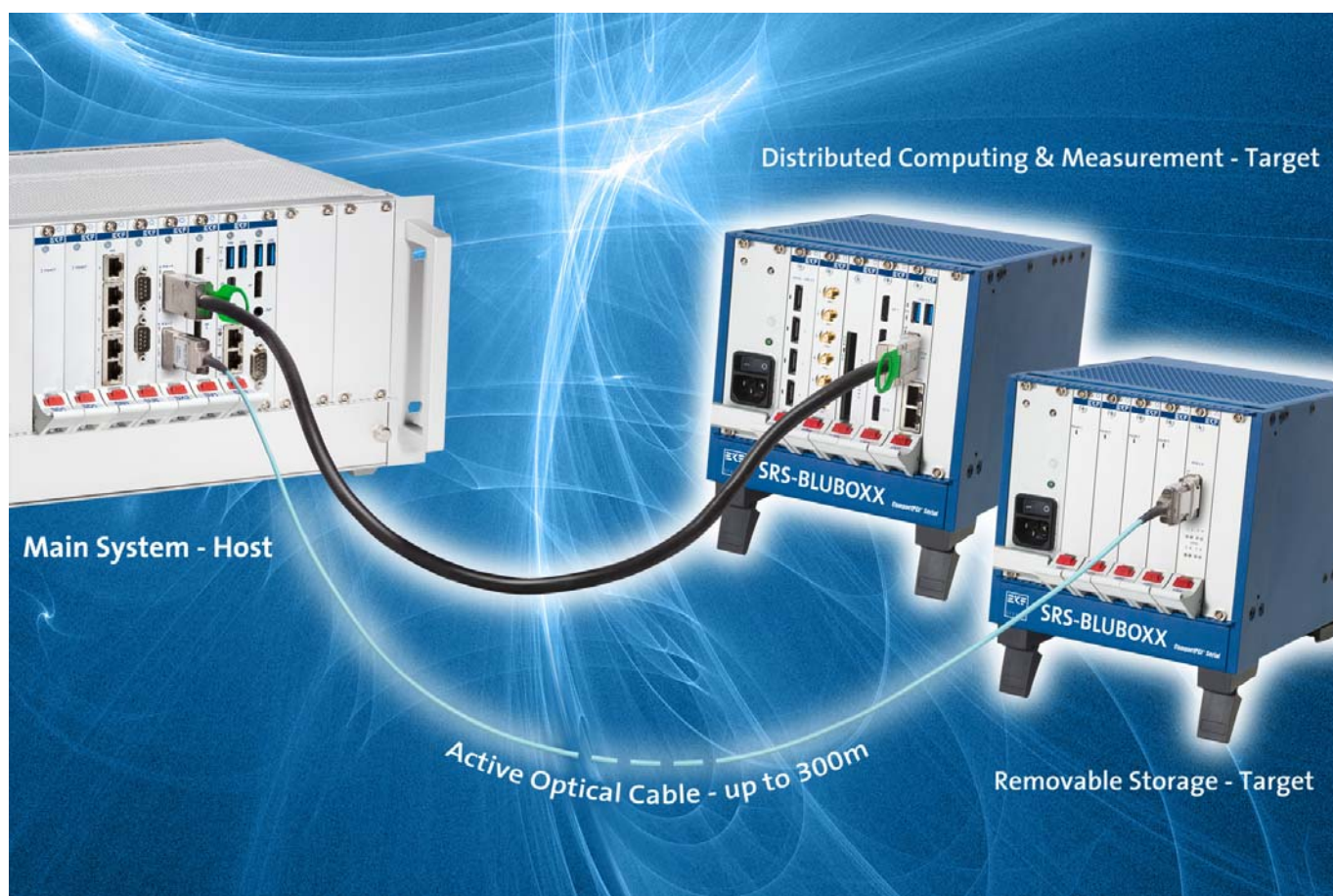

By means of the Dolphin PCIe Networking Software also peer to peer computing can be realized. The Dolphin drivers establish a 'Super Sockets' named TCP/IP stack (based on Berkeley Socket), so that existing software which is running over Ethernet can be used also across a PCIe connection between two SX2-SLIDE adapter cards, with 20Gbps transfer rate and low latency down to 0.6 μ s. The Super Sockets are available for Linux, Windows, RTX and VXworks. Please contact sales@ekf.com if interested.

Vision Systems

Top-end image processing applications are PCI Express® enabled. This solution offers the shortest latency time, as well as very high data transfer rates, as required for high resolution and high frame rate image capture.

Some industrial cameras are already provided with the PCIe x4 cable connector. The DC2-STAG would allow to attach two PCIe cameras at a nominal data transfer rate of 20Gbps each.



Application Example - High Performance Vision System w. PCIe Cabling

P15 Mezzanine Connector

The DC2-STAG is equipped with a high speed XMC mezzanine connector P15, mating with the host board J15 and establishing the data path (PCI Express®) and power link to the carrier. The pin assignment of P15/J15 is specified by VITA 42.3. The DC2-STAG is organized as 8-lane single-link PCI Express® device.

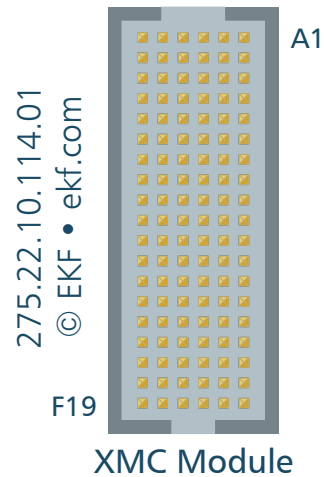

As an option, the DC2-STAG can be equipped with a P15 connector according to the XMC 2.0 style, as defined by VITA 61.0. Carrier card and module connectors J15/P15 must match - VITA 61 and VITA 42 XMC connectors are not intermateable. Both connector styles can be easily distinguished from each other by the connector body colour as visual key.

Black = VITA 42 XMC
Off-white = VITA 61 XMC 2.0

Suitable carrier cards are available from EKF, e.g. the SK3-MEDLEY CompactPCI® Serial XMC module carrier board.

XMC Connector P15 - PCIe Fabric • EKF Part No. 275.22.10.114.01						
	A	B	C	D	E	F
1	PETOP0	PETON0	+3.3V	PETOP1	PETON1	VPWR ²⁾
2	GND	GND	TRST# ¹⁾	GND	GND	MRSTI#
3	PETOP2	PETON2	+3.3V	PETOP3	PETON3	VPWR ²⁾
4	GND	GND	TCK	GND	GND	MRSTO#
5	PETOP4	PETON4	+3.3V	PETOP5	PETON5	VPWR ²⁾
6	GND	GND	TMS	GND	GND	+12V
7	PETOP6	PETON6	+3.3V	PETOP7	PETON7	VPWR ²⁾
8	GND	GND	TDI	GND	GND	-12V
9	<i>RFU</i>	<i>RFU</i>	<i>RFU</i>	<i>RFU</i>	<i>RFU</i>	VPWR ²⁾
10	GND	GND	TDO	GND	GND	GA0 ¹⁾
11	PEROP0	PERON0	MBIST#	PEROP1	PERON1	VPWR ²⁾
12	GND	GND	GA1 ¹⁾	GND	GND	MPRESENT#
13	PEROP2	PERON2	+3.3V_AUX	PEROP3	PERON3	VPWR ²⁾
14	GND	GND	GA2 ¹⁾	GND	GND	MSDA ¹⁾
15	PEROP4	PERON4	<i>RFU</i>	PEROP5	PERON5	VPWR ²⁾
16	GND	GND	MVMRO	GND	GND	MSCL ¹⁾
17	PEROP6	PERON6	<i>RFU</i>	PEROP7	PERON7	<i>RFU</i>
18	GND	GND	<i>RFU</i>	GND	GND	<i>RFU</i>
19	CLKP_XMC	CLKN_XMC	<i>RFU</i>	WAKE#	ROOT0#	<i>RFU</i>

pin positions printed italic/gray: reserved by specification / not connected

- 1) Serial EEPROM not populated by default (no IPMI)
- 2) VPWR is not required - both the SATA controller and the SSDs are sourced from +3.3V

Black = VITA 42 XMC
Off-white = VITA 61 XMC 2.0

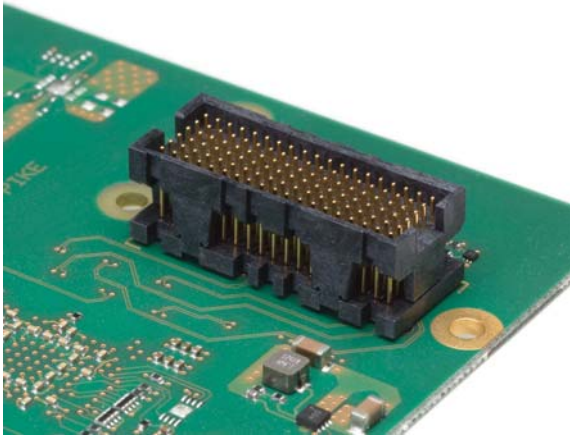

XMC Connector P15

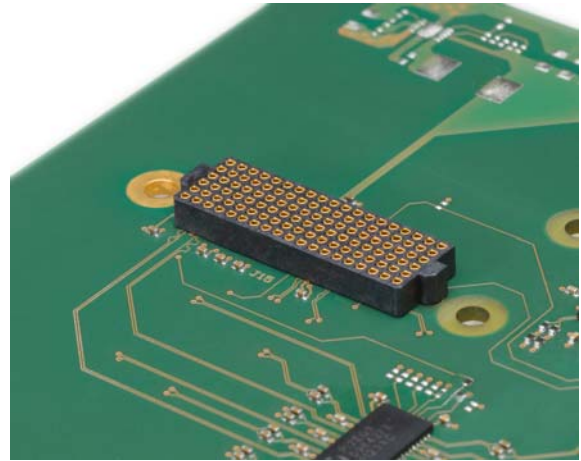

XMC Connector J15

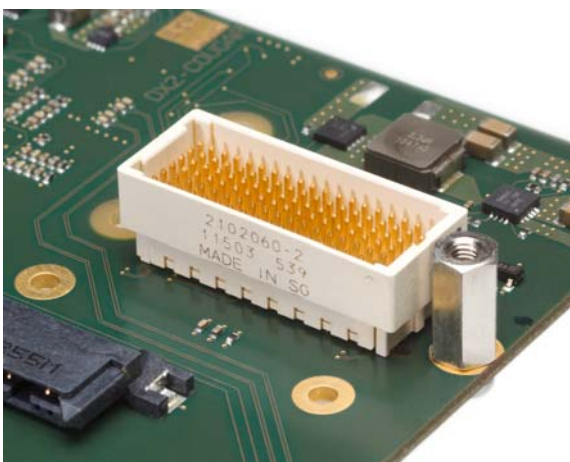

XMC 2.0 Connector P15

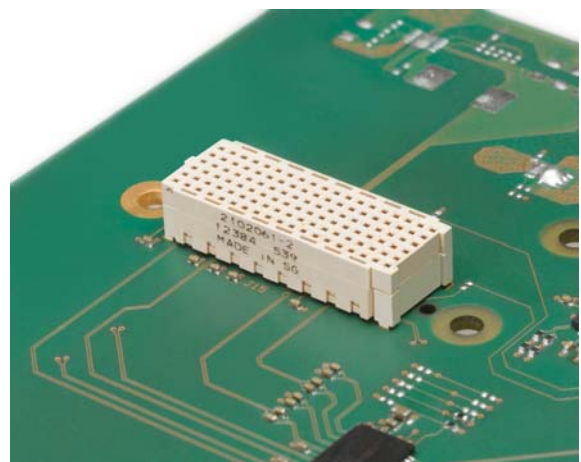

XMC 2.0 Connector J15

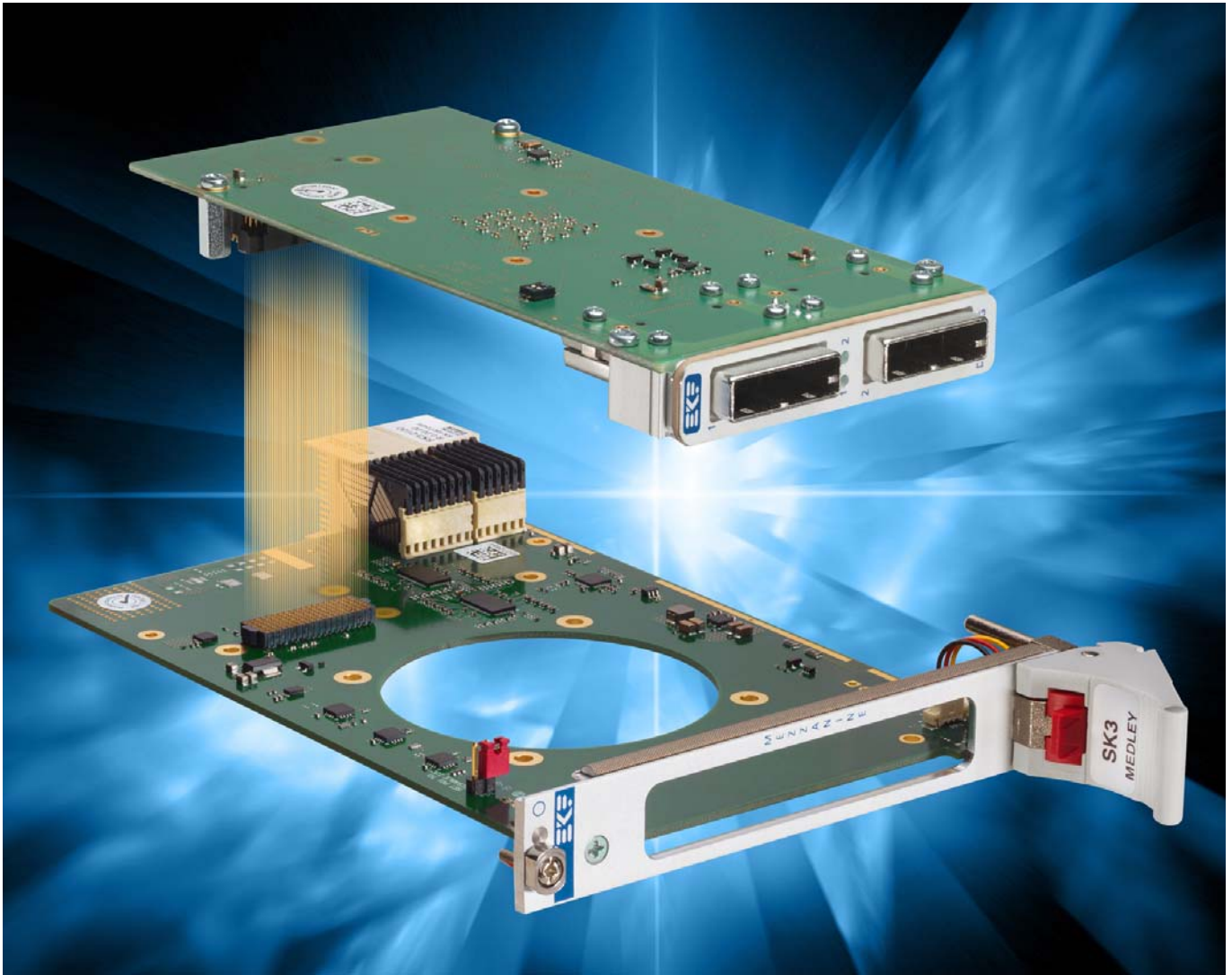

Related XMC Carrier Cards

SK3-MEDLEY CompactPCI® Serial

www.ekf.com/s/sk3/sk3.html

Related PCI Express® External Cabling Products

SX2-SLIDE CompactPCI® Serial
PCIe x 4 Host Adapter

www.ekf.com/s/sx2/sx2.html

SX9-HOWL CompactPCI® Serial
PCIe x 4 Target System Adapter

www.ekf.com/s/sx9/sx9.html

SXS-STRING CompactPCI® Serial
PCIe x 4 Target System Adapter

www.ekf.com/s/sxs/sxs.html



Beyond All Limits: EKF High Performance Embedded

Industrial Computers Made in Germany
boards. systems. solutions.

EKF Elektronik GmbH
Philipp-Reis-Str. 4 (Haus 1)
Lilienthalstr. 2 (Haus 2)
59065 HAMM
Germany



Phone +49 (0)2381/6890-0
Fax +49 (0)2381/6890-90
Internet www.ekf.com
E-Mail sales@ekf.com